



AS Classic 150 - 300

LIFT&SLIDE SYSTEMS



Open, Close, Live

AGB lift-and-slide systems

Lift-and-slide doors and windows are the ideal solution for rooms requiring a lot of sunlight, or for homes situated in panoramic areas where having large glass windows enables you to enjoy a complete view of the landscape; moreover, they offer maximum accessibility to the outside. Another advantage of the lift-and-slide system is that it requires very little space, a very convenient feature in situations where the installation of conventional swing-open doors and windows would be impossible. The weight of the frame, and the need for a safe and silent movement of the doors, requires hardware of adequate resistance and precision.

The AGB hardware for lift-and-slide systems, **AS 150** and **AS 300**, offers the ideal solution: a simple movement of the handle and the door slides lightly and silently.

The doors can have a width of up to 3,300 mm, a height of over 3,000 mm, and they can weigh up to 300 kilograms.

The aesthetic appearance of the door is pleasing and always in harmony with the architectural requirements of the building.

The great flexibility of the system allows you to close very wide openings by installing multiple lift-and-slide doors.





The basic elements

Depending on the type of application and on the weight of the sliding doors, you can choose from two different models: **AS 150** with a capacity of up to 150 kg, and **AS 300** with capacity of up to 300 kg. All the standard parts, necessary for the assembly of the single sliding door, are included in the basic kit, whereas the lock (1) and the carriage link rod (2) must be ordered separately since these elements vary according to the size of the door.

The system also includes a set of complementary accessories.

The basic kit includes:

Description	Ref. drawing	No. of components
Hardened steel fastening pins	3	3
Front carriage	4	1
Rear carriage	5	1
Carriage link rod guide	6	2
Bottom keeper	7	1
Lift-lock screw	8	1
Shaped cap for bottom track	9	1
Shaped cap for top guide	10	1
Top front guide terminal	11	1
Top rear guide terminal	12	1
Bottom rear cover cap	13	1
Rubber bumper	14	2

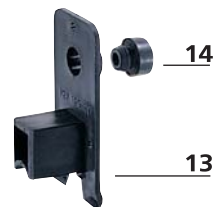
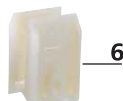
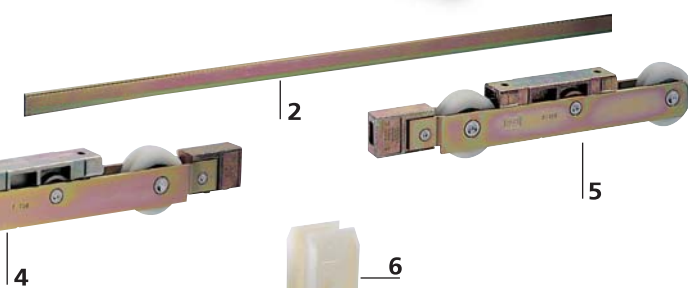
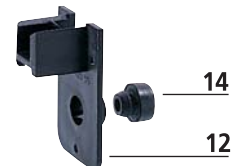

Infinite possible solutions

The AGB lift-and-slide hardware systems satisfy every possible requirement. Assemblies with one or more movable doors can be installed, with no limit in number, as long as they slide on two parallel tracks. Instructions are supplied with the hardware; for each opening arrangement they provide detailed indications for calculating dimensions, manufacture of the doors and assembly. The following patterns describe the most common arrangements.

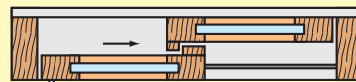

Pattern A
1 fixed door and 1 sliding door



Pattern B
2 sliding doors



Pattern C
2 fixed doors and 1 sliding door



Pattern D
1 fixed door and 2 sliding doors

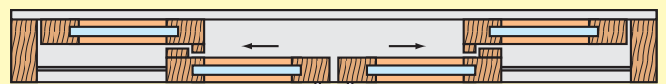

Pattern E
2 fixed doors and 2 sliding doors

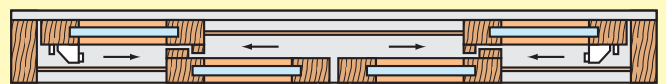

Pattern F
4 sliding doors

Accurate and controlled finishes

Aluminium parts are natural anodized in compliance with current regulations, with a minimum thickness of 15 microns. The thickness of the coating is controlled in compliance with UNI/ISO 2360.

The components made of steel and zinc alloy, which are not usually visible after the doors have been assembled, are treated with static electrolytic zinc plating and subsequent chromic passivation in compliance with UNI 2081.

Components

Lock

The sturdy casing is in sheet steel, with 27.5 and 37.5 mm backset, which can house a euro profile cylinder.

The face, with a variable height of 800 to 2400 mm, is in silver anodized aluminium (F1) or dark bronze anodised finish (F5).

For particular applications to the face plate, a 500 mm extension can be added.

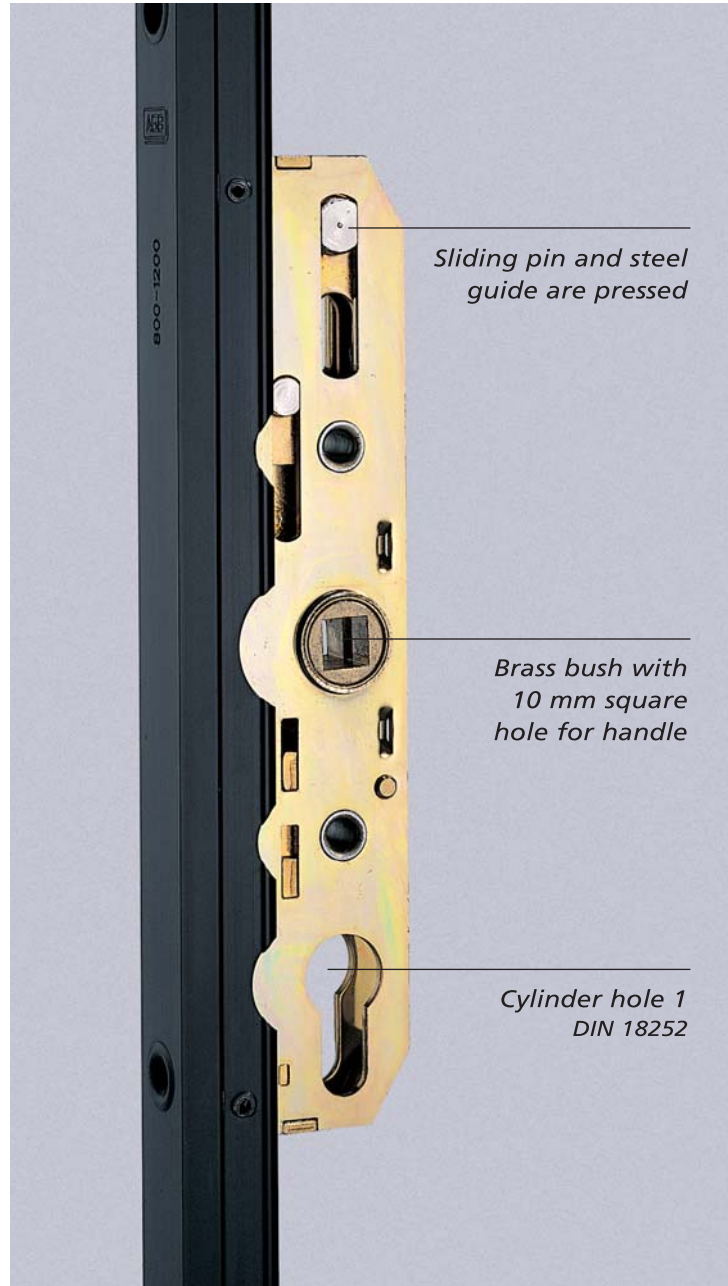

Sliding pin and steel guide are pressed

Brass bush with 10 mm square hole for handle

*Cylinder hole 1
DIN 18252*

Carriages

The sturdy precision carriages that support the movable doors ensure easy lifting, perfect sliding, smooth and silent operation. The front and rear carriage are connected by a cut-to-size steel link rod.

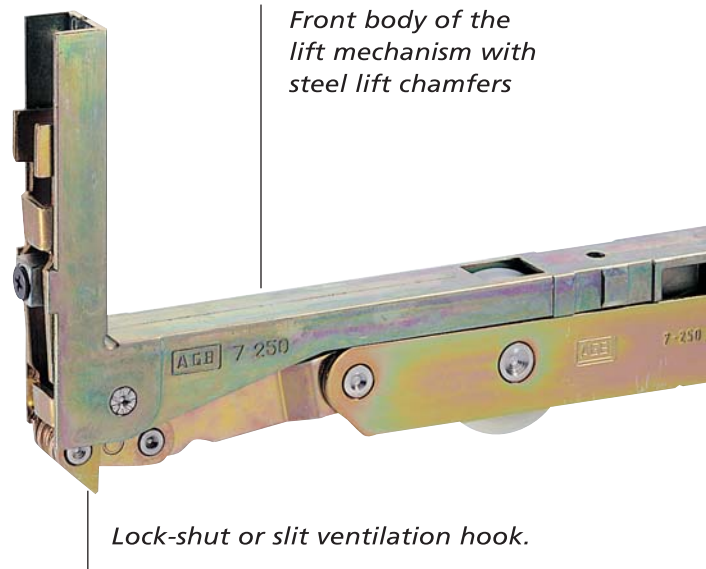

Front body of the lift mechanism with steel lift chamfers

Lock-shut or slit ventilation hook.

Fastening pins

The normal fastening pins are in pressed steel, hardened and with zinc plated. The pin for coaxial doors is made of brass.

Normal type fastening pin

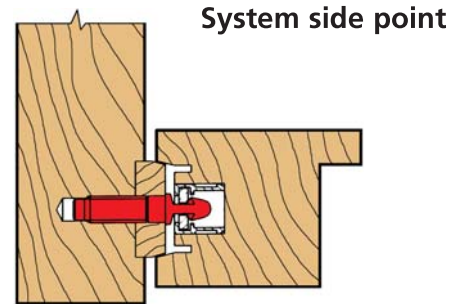

Pin for coaxial doors

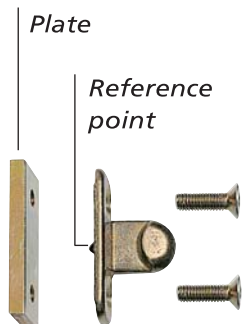

For the asymmetric solution the pin is inserted in the slit of the cremone bolt and locked by the plate which is fastened by two screws.

For the symmetric solution the position of the pins is determined by means of the special template inserted in the cremone bolt.

System central point coaxial doors (pattern E-F)

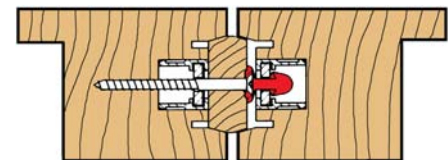
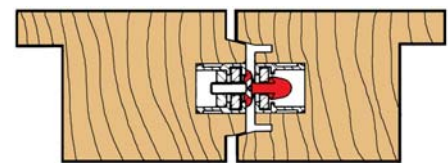

Wheels in extra hard nylon mounted on screened ball bearings ensure long life and excellent sliding performance

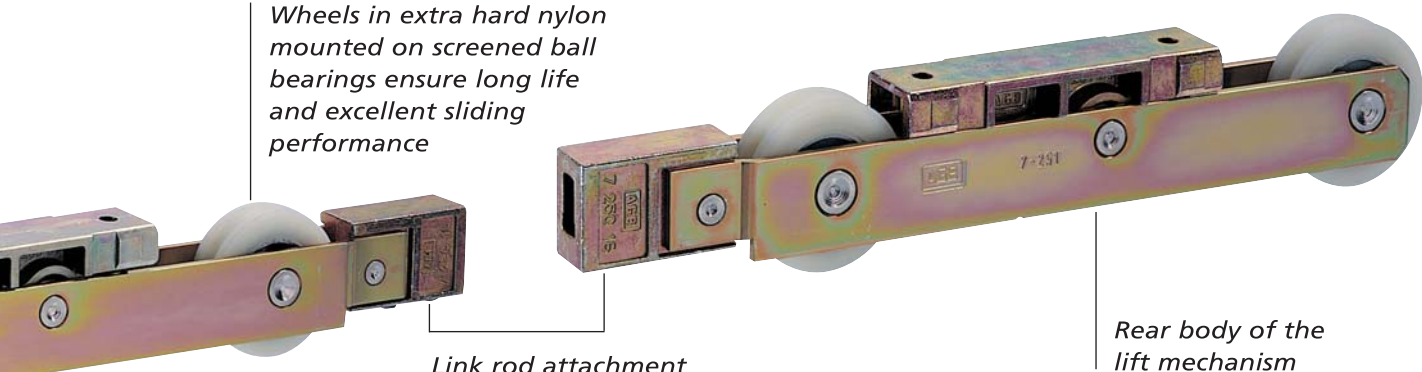

Link rod attachment blocks with two stop dowels

Rear body of the lift mechanism

● Carriage link rod

It is a shaped, zinc plated finish, 5x8 mm steel bar which links the front carriage to the rear one.

It can be adapted to sliding doors with a width of 650 to 3300 mm.

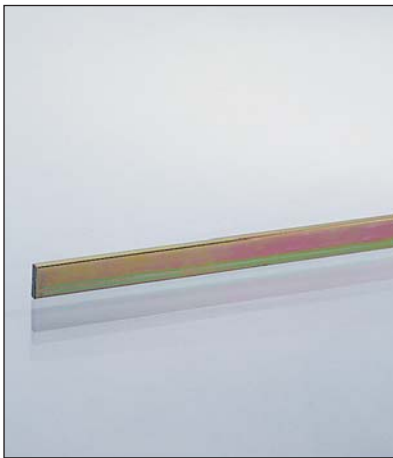

● Carriage link rod guide

For wide sliding doors. Manufactured in self-lubricating plastic material, it helps the sliding of the carriage link rod, preventing its twisting or bending. It is applied on the bottom rail of the door, in the milled section housing the carriages, at a distance from these of at least 50 mm. Two guides are included in the standard basic kits.

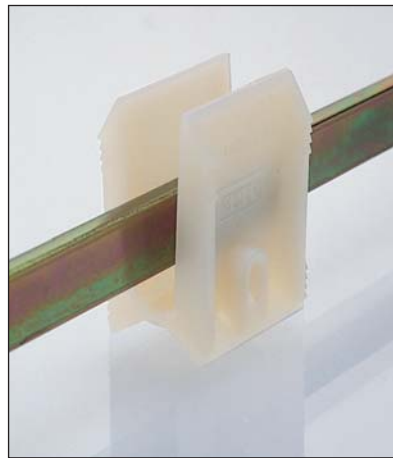

● Bottom keeper slit ventilation stop

The door can be set ajar, leaving an opening for the circulation of air, without impairing the security of the system. In the completely shut position this element greatly increases the resistance to the efferaction of the door. It is applied on the bottom track next to the door jamb. Included in the basic kits.

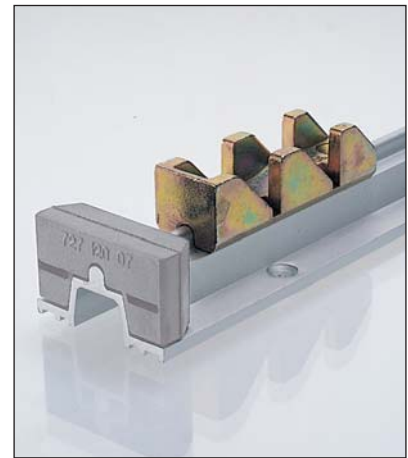

● Lift-lock screw

Positioned on the top rail of the frame and suitably adjusted, it allows the sliding door to be lifted only so far as is strictly necessary for opening.

In the closed or ajar position, if combined with the aeration stop, it is an excellent added security measure against break-in attempts.



● Shaped caps for bottom and top tracks

Manufactured in black rubber.

Can be mounted on any aluminium track and their utilization allows for the speedier preparation of the counter-strip, which will no longer have to be adapted to the shape of the track but simply cut to size.



● **Top front guide terminal**

Used to cover the cut-to-size end of the aluminium lock face.
During the sliding, it reduces the vibrations of the assembly and increases the resistance to forced entry, since it hinders the lifting of the sliding door.



● **Top rear guide terminal**

Prevents the shaking of the sliding door and reduces vibrations. It also obstructs lifting, thereby improving security. Finally, thanks to the rubber bumper, it softens the impact of the door against the jamb.



● **Bottom rear cover cap**

Used to cover the milled section housing the carriages on the bottom rail. Thanks to the rubber bumper, it softens the impact of the door against the jamb.



The lift-and-slide system is also suitable for windows where, in addition to reduced dimensions, there is a need for security, resistance and sturdiness.

● 500 mm extension for locks

Used when the sliding door is higher than 2400 mm or, in particular cases, to lower the handle from 1010 mm to 410 mm on doors that are higher than 1800 mm.

To increase the resistance of the system a screw-type fastening pin can be applied to the extension.



● Door bumper

In plastic material and black rubber, it softens the impact of the sliding door against the frame. It is suitable for sliding doors with interior-exterior handle, and for movable doors whose width is smaller to that of the fixed panes.

It is used also on lift-and-slide assemblies with multiple movable doors sliding on parallel tracks and overlapping each other.



● Angle connection for tubular threshold

Used to connect the jambs with the tubular threshold or the cover threshold. The kit also includes a special shaped seal that allows for the perfect coupling of the structural elements. A template is available to speed up and facilitate the application.



● Bottom lateral flexible seal

It is applied on the lock-side stile, on the bottom rail of the sliding door, and on the strips applied to the central point of the system, regardless of the opening arrangement or of the number of sliding doors.

Available in 40 and 200 metre kits.

● Top flexible seal

It is applied on the top rail of each sliding door, regardless of the opening arrangement and of the number of sliding doors. It acts upon the top guide in the closed position.

Available in 40 and 200 metre kits.

● Gliding rail seal

For systems with multiple doors sliding on parallel tracks. It prevents water infiltration when the tubular threshold or the cover threshold are applied in combination with the gliding rail.

Applied in the special housing of the shaped edge of the gliding rail, exclusively along the LB length of the door, in the closed position.



• **Kit for "C" track**

- Front glider with gap
- Rear glider with bumper
- End buffer for "C" track



• **Top insulating strip**

- Brush insulating strip, for reduced guide
- Top insulating pad



• **Bottom insulation strip**

- Low sealing pad
- Sealing pad, for cover threshold and sill
- Sealing pad, for low cover threshold

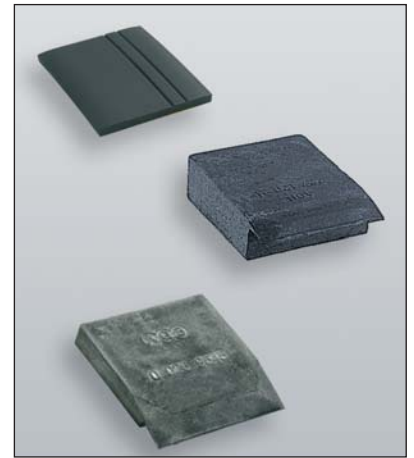

• **Anti-burglar components**



• Anti-burglar central lock



• Anti-burglar plate for gliders



• Anti-burglar sash/sash (coaxial) pin



• Anti-burglar locking pin

Tracks



- "C" track
- Snap-in rail for "C" track
- High track with removable stainless steel rail
- Low bottom track
- High bottom track
- Low cover threshold with thermal brake
- Cover threshold with high track
- Tubular threshold with high track

Guide



- Reduced top guide
- "C" track
- Universal top guide
- Top guide with covering contour

Complete set of bottom tracks and top guides in anodized aluminium, with silver (F1) and dark bronze (F5) finishes.

The chamfering of the track has been studied to ensure the optimum precision sliding ratio of the carriages and the long life of the wheels. We therefore do not advise using tracks with different contours, as they would compromise the functionality of the system.

The handle kits of the AS system include fastening screws and are available in the following models:

• Short handle

For lift-and-slide window systems with internal lock mechanism only; no keys necessary.



• Handle with cylinder slot and external moulding

For lift-and-slide systems with key operated, internal lock mechanism only.



• Handle and external moulding

For lift-and-slide systems with internal lock mechanism only; no keys necessary.



• Internal/external handle

For lift-and-slide door systems with internal/external key operated lock mechanisms.



The handles are manufactured either in brass or aluminium. The available aluminium finishes are:

- dark bronze anodised finish (F5)
 - silver anodized (F1)
- Brass finishes:
- polished and lacquered
 - anthracite grey (shiny black)

A comprehensive service

The AGB lift-and-slide hardware systems are very convenient because of their technical characteristics and commercial value; but for AGB this is not enough.



AGB offers its customers a series of technical instruments (milling cutters, templates, etc.) to facilitate and speed up production; it also offers a valuable consulting and assistance service which includes, in addition to wide technical documentation, on-site visits by specialized technicians.

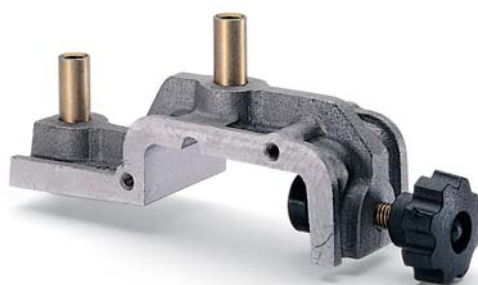

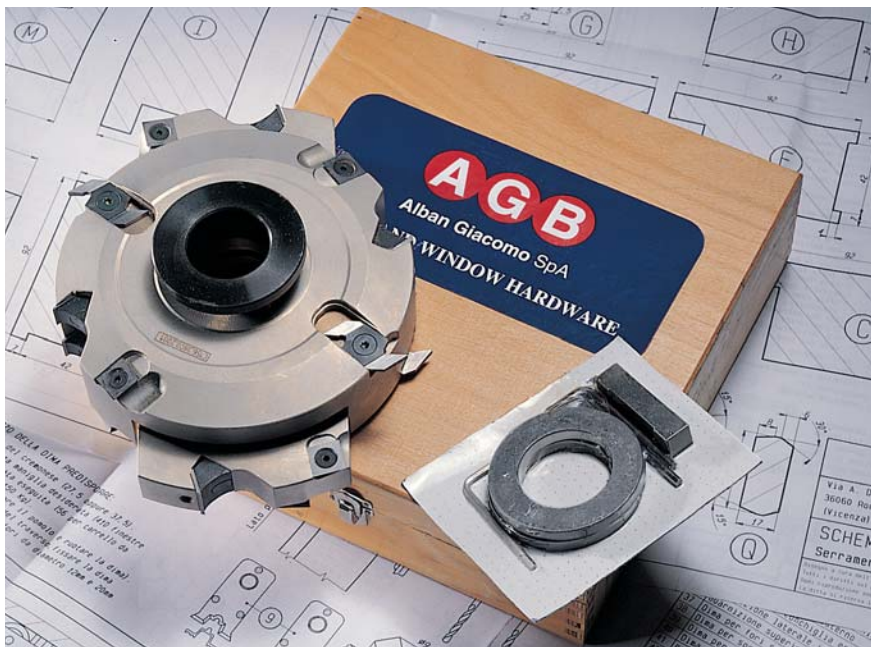



Open, Close, Live

The supplied data and pictures are to be considered valid saving any printing errors or modifications introduced by the manufacturer.

Alban Giacomo SpA
Via A. de Gasperi, 75
36060 Romano d'Ezzelino (VI) Italy
Tel. +39 0424 832 832
www.agb.it - info@agb.it

Alban Giacomo S.p.A.
Via A. De Gasperi, 75
36060 Romano d'Ezzelino
(Vicenza) Italia
Tel. +39 0424 832 832
www.agb.it - info@agb.it