



Open, Close, Live



FOR THOSE WHO
WANT MORE,
FOR THOSE IN
SEARCH OF THE
GREAT WIDE OPEN,
NO BOUNDARIES,
BEYOND.

IMAGO⁺

BEYOND A DOOR



IMAGO⁺

THE CREATIVITY FLIES BEYOND A DOOR

Slimmer profile, wider space to the light.
The xc s-line hardware allows to realise big and heavy sashes up to **400 kg**
with minimal profiles: the lower transom has been reduced to **50 mm**.



IMAGO⁺

IMAGO+ invites to go beyond and transcend borders. Interior rooms and external places communicate and blend together. The profiles almost disappear, Imago+ means high creativity and more solutions.

DESIGN



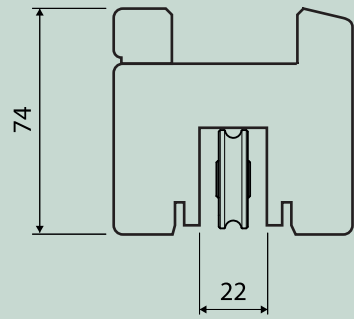

SLIMMER PROFILE AND HEAVIER SASHES

The new XC S-Line carriages allow big and heavy sashes with reduced profiles.

Incredible performance and minimal design: 400 kg loading capacity, a lower section reduced up to 74 mm and great comfort thanks to an extraordinary smooth sliding.

SLIMMER PROFILE

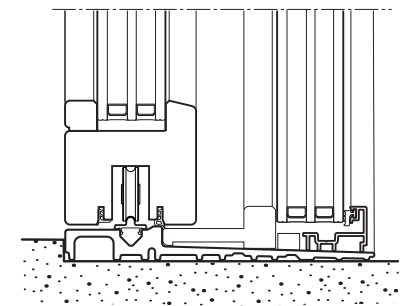
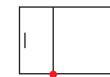

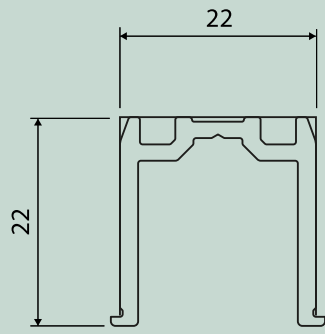

MINIMAL DESIGN

When the door becomes a design element, even the smaller detail becomes important. This means concealed hardware.

The guide is completely embedded into the frame, it conceals the door stopper and houses the safety Auto Brake.

THE DETAIL THAT ENHANCES THE DOOR

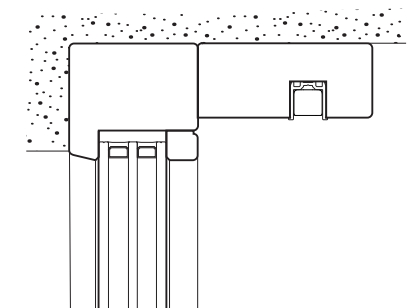
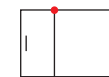
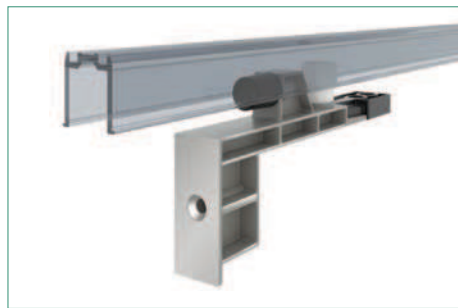

COMPLANATION OF THE FLOORING

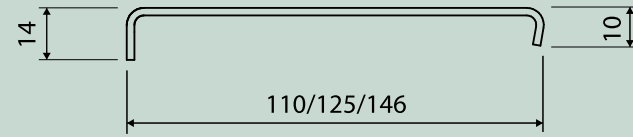

NO BARRIERS, THE BEST DESIGN

The cover of the threshold allows a flush installation between inside and outside. Barrier free passage, with premium design.

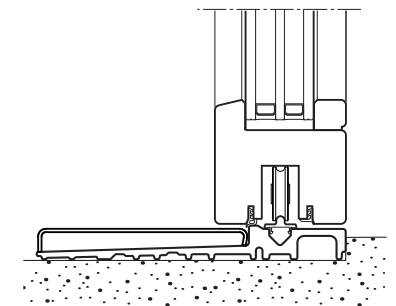
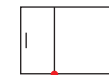
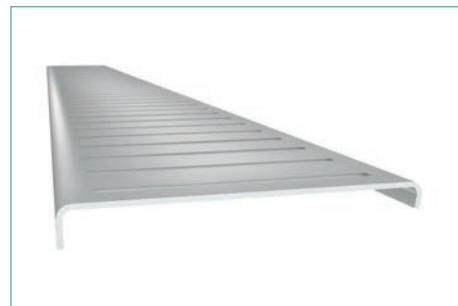

THE ESSENTIAL IN THE DETAILS

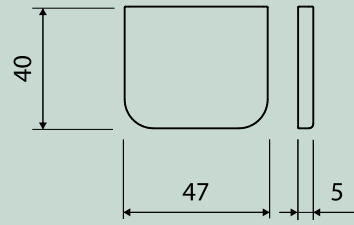

WOOD AND IMAGE ONLY: THE HARDWARE DISAPPEARS INTO THE FRAME

All the functional components are concealed, no visible screw. Also the door stopper is integrated in the concealed glider. The top and bottom caps have an essential and clear shape.

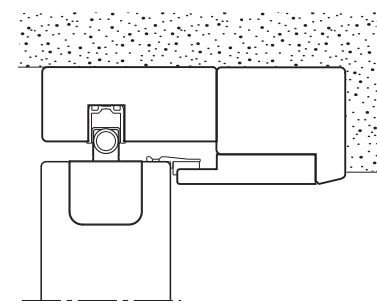
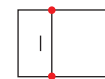

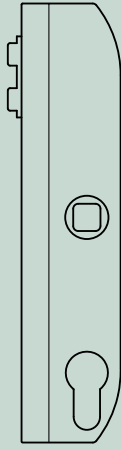

REDUCED JAMB WIDTH

Thanks to an innovative wood working, only 50 mm of the locking jamb are visible.

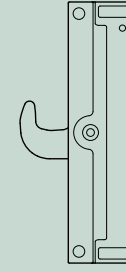

THE HOOKS LOCK, ABSOLUTELY SECURE!

The closing operation and the hook shape prevent to unhinge the sash while lifting. Even if forcing the hook, it is impossible to operate the hardware.

When the sash is open, the hook retracts into the profile, avoiding any protrusion. In the frame side, the adjustable striker doesn't require millings and it is flush with the profile.

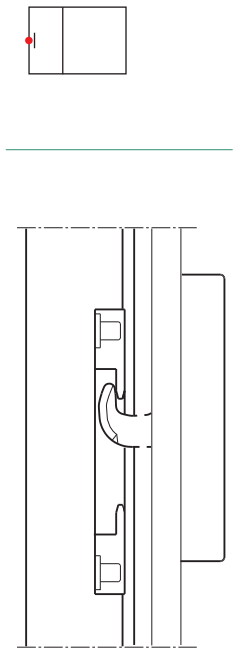
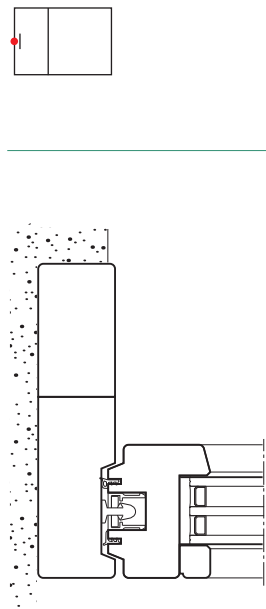



THE INSTALLATION THAT HIDES THE FRAME

Thanks to a new dedicated cap and a proper installation, the frame disappears, both the lock side and the top transom, like the fixed sash.

IMAGO+ is a step further to a minimal and all-glass design.



A FINE INSTALLATION

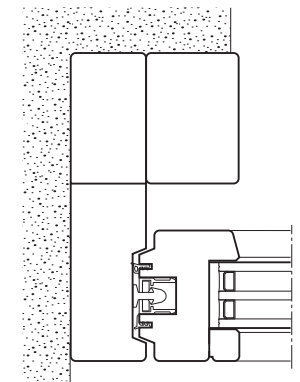
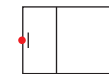
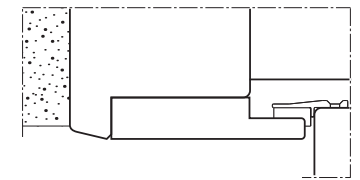
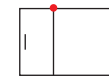

PERFORMANCE



THERMAL INSULATION AND SECURITY

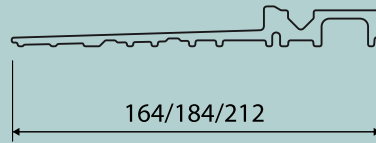

CAREFUL DESIGN WITH A STRONG BASIS

A 25 mm thickness flattened by a complete installation.
The Climatech threshold allows minimal design and guarantees incredible thermal performance thanks to the innovative composite material reinforced with fibreglass.
IMAGO+ is a barrier against air, water and wind thanks to a range of accessories which have been tested in any weather condition.

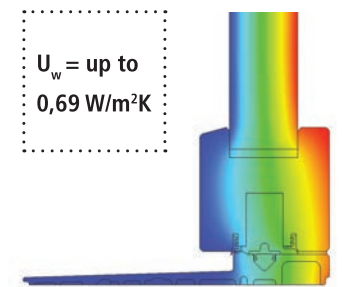
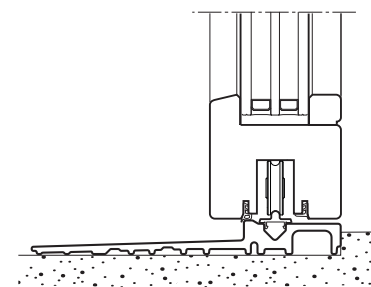
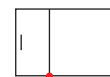

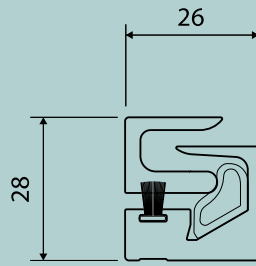

MINI UNI-V CENTRAL POINT

The best performance in the least space: in 26 mm only, all the Uni-V features are concentrated.
The new interlocker offers wide working tolerances and compensates the natural deformation of wood: together with terminal caps, it ensures great performance of air, water and wind proofness.

The reduced dimensions allow to embed it between two wooden profiles: when the door is closed, the interlocker disappears. When the sash is open, covers hide the screws for a clean design.

ADVANCED INNOVATION

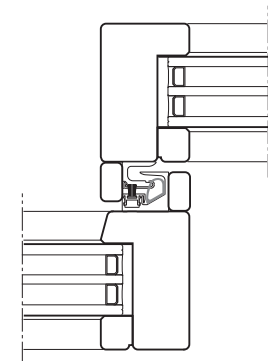
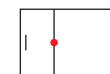



AUTO BRAKE SYSTEM

The safety Auto Brake system slows down and stops the sash before it reaches the frame.
It can be used in opening and closing on the same sash at the same time.
During the opening operation, Auto Brake is quite imperceptible, ensuring the maximum comfort.

SAFETY AND COMFORT

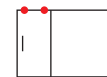
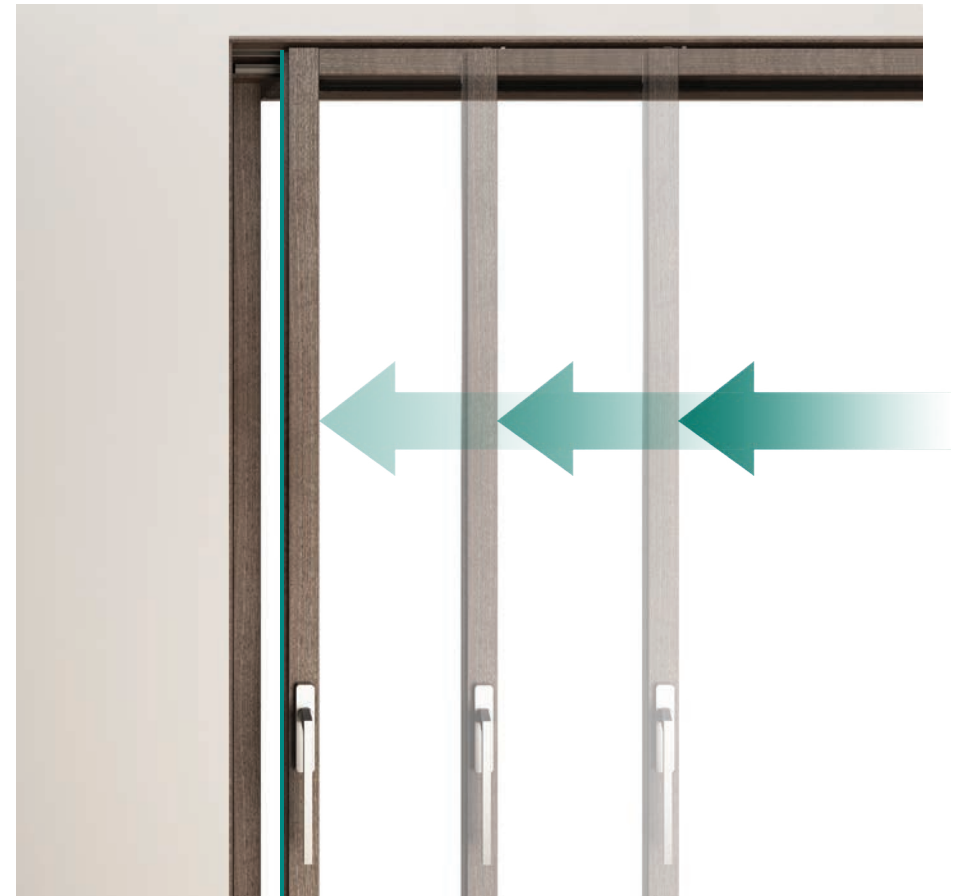

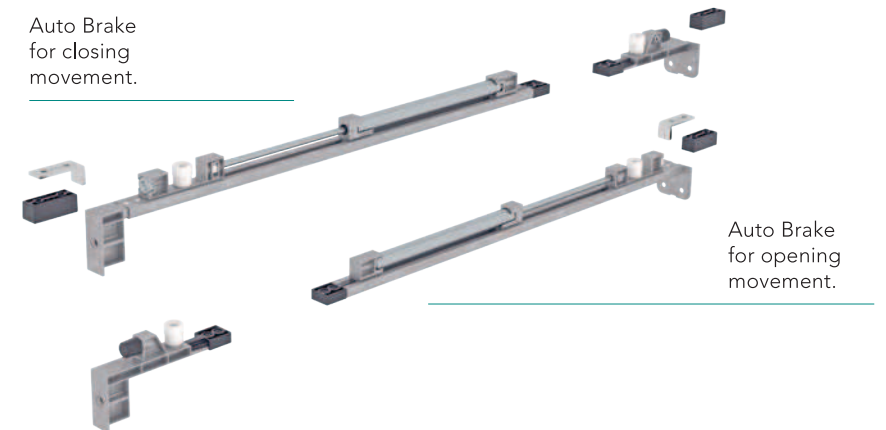

Auto Brake
for closing
movement.



Auto Brake
for opening
movement.

IMAGO⁺

-  100% wood
-  100% energy saving
-  100% made in Italy



IMAGO⁺

BEYOND A DOOR



Open, Close, Live

Alban Giacomo spa
Via A. De Gasperi, 75
36060 Romano d'Ezzelino (VI) Italy
+39 0424 832 832
www.agb.it - info@agb.it

MADE IN ITALY

